

Reference

Digital-Analog Converter

MANUAL



THANK YOU

for purchasing a product from TRINITY Electronic Design.

The **TRINITY DAC** with its patented **LIANOTEC** architecture sets new standards so that discerning music aficionados can finally enjoy their most beautiful recordings as if it were the true to life original.

The DAC supports the playback of audio files with 44.1kHz – 192kHz sampling rates and 24bit resolution.

The asynchrony USB interface is galvanic de-coupled from the computer side and is synchronized with two full customized, hermetic sealed **Voltage Controlled Oven Controlled Xrystal Oscillators VCOCXO**, which deliver the 2 master clocks of $44.1\text{kHz} \times 512 = \mathbf{22.579200.0\text{MHz}}$ and $48\text{kHz} \times 512 = \mathbf{24.576000.0\text{MHz}}$.

The exact frequency can be fine-tuned on the back of the DAC to compensate any aging for the next 20years.

Both clocks are available as a 50Ohm output signal on the back of the DAC to be used as a master reference clock.

The **accuracy is 1ppb or 0.02Hz** (factory setting) with a tuning range of +/-1000ppb.

The outstanding **extreme low jitter is 28fs** (10Hz-100kHz).

These VCOCXOs are **very low sensitive to any acceleration with 1ppb/g**, measured in the worst case axis.

Enjoy pure sound reproduction with our product.

Sincerely Yours

TRINITY Team





CONTENTS

Safety Instructions	5
Scope of Supply	6
Transportation and Cleaning	6
Selecting the Power Voltage	7
Connecting and Starting	7
Wiring Up.....	8
Technical descriptions	9
THE FINAL MEASUREMENTS.....	20
Warranty.....	27
Support.....	28

SAFETY INSTRUCTIONS

1. Please read this operating manual carefully and observe all the instructions affixed to the appliance or written in this manual.
2. Install this product on a stable surface and make sure that nobody can trip over the cables.
3. This product should only be connected to a power source indicated on the product. If you are unsure what power source you have in your region, please contact your local power utility.
4. Never operate this product near water or with wet hands. If the product comes in contact with liquids, immediately disconnect it from the power source.
5. To exclude the risk of an electric shock, please never expose the product to the rain or other source of liquid.
6. In thunderstorms, do not install the product or put it into operation.
7. Never attempt to open the appliance or repair it yourself. If you open or remove the enclosure, you may expose parts that are subjected to dangerous levels of voltage. Any unauthorized opening of the appliance will cause the warranty claim to become null and void.
8. Do not allow children to play with electrical appliances without adult supervision. Children do not always recognize the possible risks and consequences.

SCOPE OF SUPPLY

The scope of supply comprises:

- TRINITY DAC
- USB Stick with Windows drivers and Sample Rate Test Files,
- Adjustment Tool
- Cotton gloves
- Cleaning cloth
- 1 x Flight Case, weight: 13.5kg, dimension: 55cm, 46cm, 24cm

TRANSPORTATION AND CLEANING

Please only transport the parts listed in the scope of supply in the supplied flight case and use the supplied cotton gloves when unpacking and installing the appliances to avoid scratching the enclosures.

Clean the surfaces using the supplied microfiber cloth: immerse the cloth in lukewarm water containing no detergents and then carefully wipe the surface when the cloth is almost dry.

Never use chemical or aggressive detergents.

SELECTING THE POWER VOLTAGE

The implemented wide-range switched mode power supply modules allow an operation from 100Vac to 240Vac. The two fuses on the primary side are placed inside of these modules.

CONNECTING AND STARTING

To install the DAC, select a stable, level surface directly next to the turn table so that the connecting cable to the tone arm is as short as possible. Avoid placing the appliance in direct sunlight and never place the modules directly next to radiators or fan heaters.

Protect all supplied parts from humidity and moisture.

Only wire up the components when the device is switched off.

WIRING UP AND USB DRIVER INSTALLATION

1. Disconnect the DAC from the power source. Never disconnect any wires unless the device is switched off.
2. Connect the DAC inputs to the audio sources.
3. Connect the DAC to the LINE PREAMP.
4. The MAC Operating Systems does not need a special USB driver.
5. The Windows Operation System needs an installation of a dedicated USB driver, which is on the USB stick.
6. Follow the instructions of the installation procedure.
7. Choose the right output device and parameters in your media player.

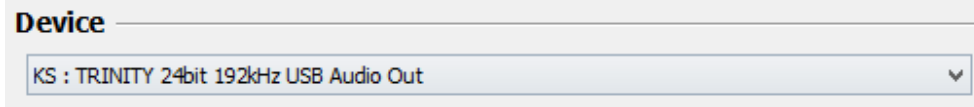

9. Play the supplied Sample Rate Test files with 6 different sampling rates and check the displayed sample rate on the back of the DAC. If the setting of the media player is correct, the related LED should indicate the correct sampling rate.



LIANOTEC®

Linear Analog Oversampling Technology

In an article entitled “A Mathematical Theory of Communication” published in 1948, Claude E. Shannon described his theory on signal sampling. See also: <http://cm.bell-labs.com/cm/ms/what/shannonday/paper.html>.

In simple terms, the Nyquist theorem presents the minimum sampling rate that is required to reconstruct the original signal without aliasing errors. In other words, the Nyquist theorem may be regarded more or less as a summary of this paper. What many will overlook is the fact that this paper makes no mention of signal amplitude or phase. The result of this is that many articles have appeared in the hi-fi press presenting the sampling theory incorrectly. To avoid any similar misinterpretations with our LIANOTEC® arrangement, we want to describe in closer detail what this innovative technology has to offer.

Digital/Analog converter

The time-discrete output signal of a digital/analog converter is a staircase signal. *Figure 1* shows a 20-kHz sine-wave signal in the time and frequency domains measured directly at the output of the D/A converter. Besides the 20-kHz signal, the frequency domain shows pairs of frequencies that are referred to as sidebands. Their frequency results from the sampling rate and the signal. In this case, the sampling rate is 384 kHz and the signal is a 20-kHz sine-wave. The sidebands are situated symmetrically in relation to multiples of the sampling frequency, i.e. the first two sidebands are at 364 kHz and 404 kHz ($384 \text{ kHz} \pm 20 \text{ kHz}$), the next pair is at 748 kHz and 808 ($2 \times 384 \text{ kHz} \pm 20 \text{ kHz}$), etc.

Spice simulation of a common multi bit DAC architecture

Time domain

Frequency domain

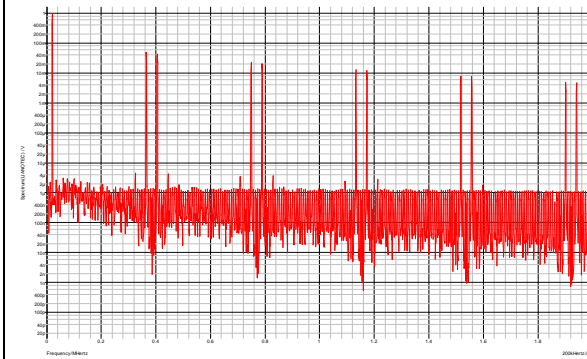
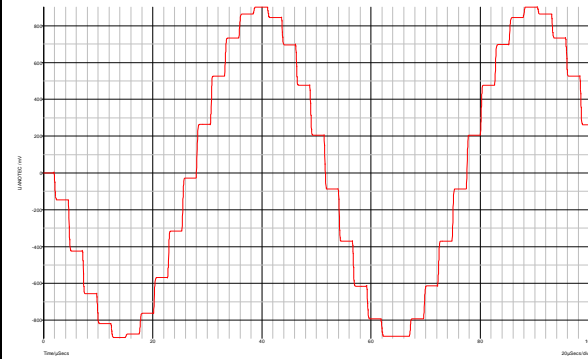

20-kHz sine wave sampled at 384 kHz, no analog LP filter

20-kHz sine wave sampled at 384 kHz, no analog LP filter

Figure 1

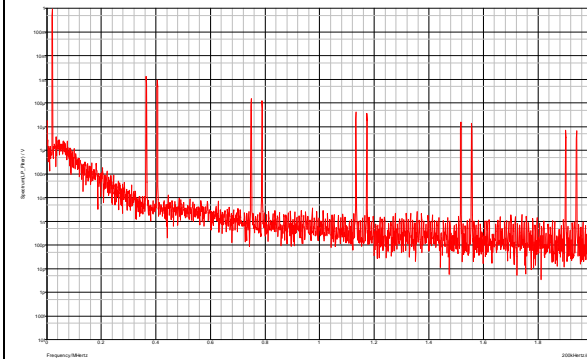
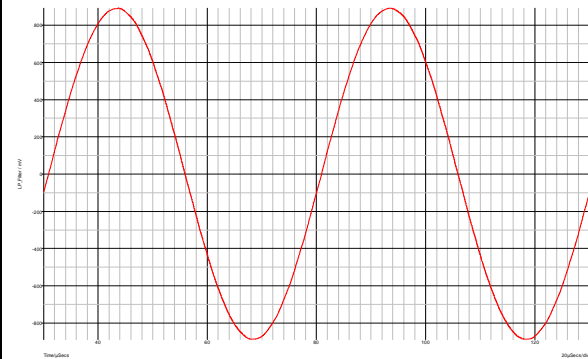

20-kHz sine wave sampled at 384 kHz plus 60 kHz analog LP filter

20-kHz sine wave sampled at 384 kHz plus 60 kHz analog LP filter

Figure 2

The Low-Pass Filter

Figure 3 shows the recommended low-pass-filter circuit and its frequency response. These frequency components must be filtered out, of course. This is the task of the analog low-pass filter which is located downstream of every conventional D/A converter. Figure 2 shows the output signal of the D/A converter downstream of a 60-kHz low-pass filter. Even if the sine-wave signal looks smooth, the FFT shows that the high-frequency components are attenuated from 50 mV to approx. 1 mV, but not completely removed.

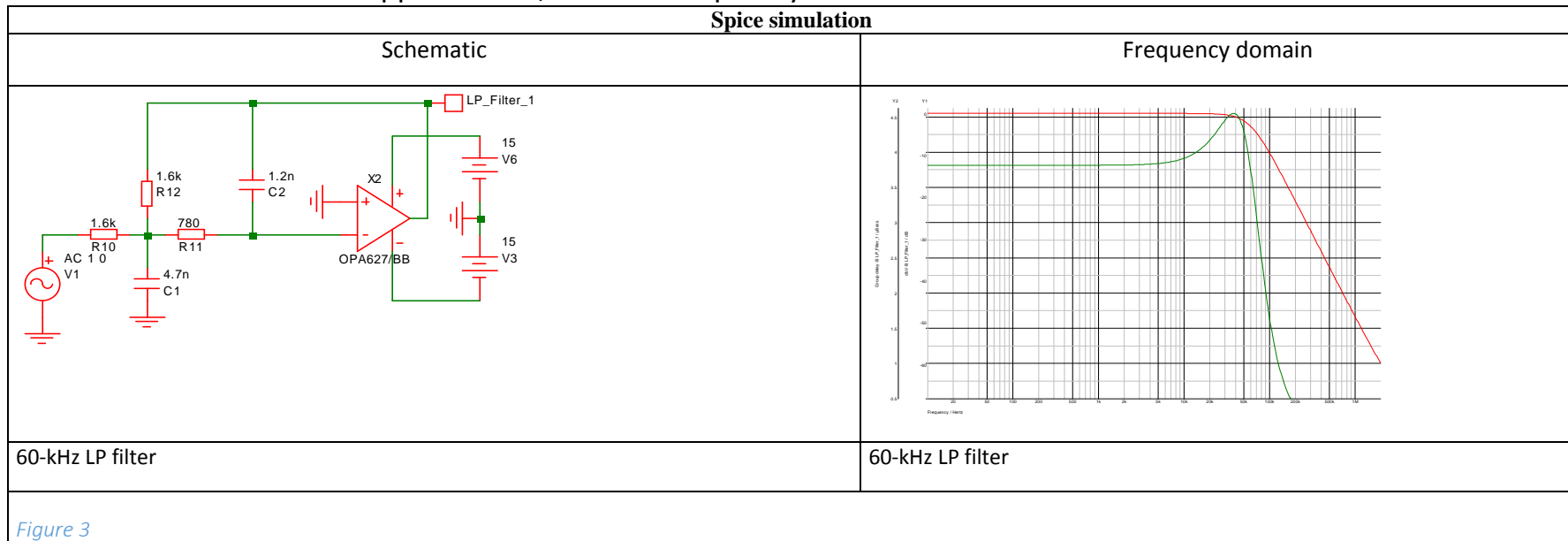

Figure 3

The frequency response shows the attenuation of -32 dB at 384kHz. The FFT showed that the spectral components of 50 mV were attenuated to approx. 1 mV. The attenuation in dB results as follows: $20\log(1 \text{ mV}/50 \text{ mV}) = -34 \text{ dB}$. We discovered that the proposed second-order 60-kHz low-pass filter failed to filter out all of the interfering frequencies. As a result, it is possible to deploy a higher-order low-pass filter, or lower the cut-off frequency from 60 kHz to 20 kHz. Either measure would result in greater suppression of image frequencies, but the two measures together would clearly contribute to an impairment in the sound. In the first case, there would be more electronic circuitry in the signal path; in the second case, there would be a slight drop in frequency response. Even group delay distortion, the curve depicted in green, would deteriorate in both cases. What is astonishing is that all of these negligible changes are clearly audible.



LIANOTEC

This is where LIANOTEC[®] comes in. The abbreviation stands for Linear Analog Oversampling Technology.

This innovative circuit topology was developed and patented by GTE GmbH and is now used by the spin-off TRINITY Electronic Design GmbH.

It is based on the fact that additional oversampling points are obtainable by multiplying the number of D/A converters and finding the right way to control them. This new type of interpolation is called LIANOTEC, since these interpolation points are situated linearly between the original sampling points and are implemented without any digital signal processing.

The whole thing in the TRINITY DAC behaves like a quadratic series. Therefore, it means that two D/A converters are needed for 2-way analog oversampling, 4 for 4-way oversampling, 8 for 8-way oversampling, etc.

The use of several D/A converter circuits in a single product is nothing new in itself. Burr-Brown brought out a similar design as demo board EVM1702 in 1997. This concept was also launched on the market in different products. In all these solutions, all the D/A-converter inputs and outputs are interconnected. This is made possible since the D/A converters supply an output current that is easy to accumulate. However, this type of parallel circuit produces only a slight reduction in errors, such as nonlinearities, harmonic distortion, and noise. The high-frequency interfering components remain untouched and must even be attenuated in a downstream low-pass filter.

The LIANOTEC[®] arrangement is totally different. Here, only the outputs are interconnected. The inputs are supplied with the required data by an additional control circuit. The electronic circuitry in this case is arranged precisely on top of the actual converter board. This minimizes the connections to the converter circuits to exactly the same length for all ICs.

Figure 1 shows that the sidebands, as described in the theory, are multiples of the sampling frequency.

2x LIANOTEC

Figure 4 shows the output signal of an innovative 2-times analog oversampling arrangement. This shows very clearly which potential this unique circuit topology introduces.

Note that the two sidebands at 384 kHz are fully suppressed.

Not only the multiples, but all of the other odd multiples of 384 kHz ($1 \cdot F_s = 368$ kHz, $3 \cdot F_s = 1.152$ MHz, $5 \cdot F_s = 1.920$ MHz, $7 \cdot F_s = 2.688$ MHz, etc.).

The remaining visible sidebands are located at all multiples of 768 kHz.

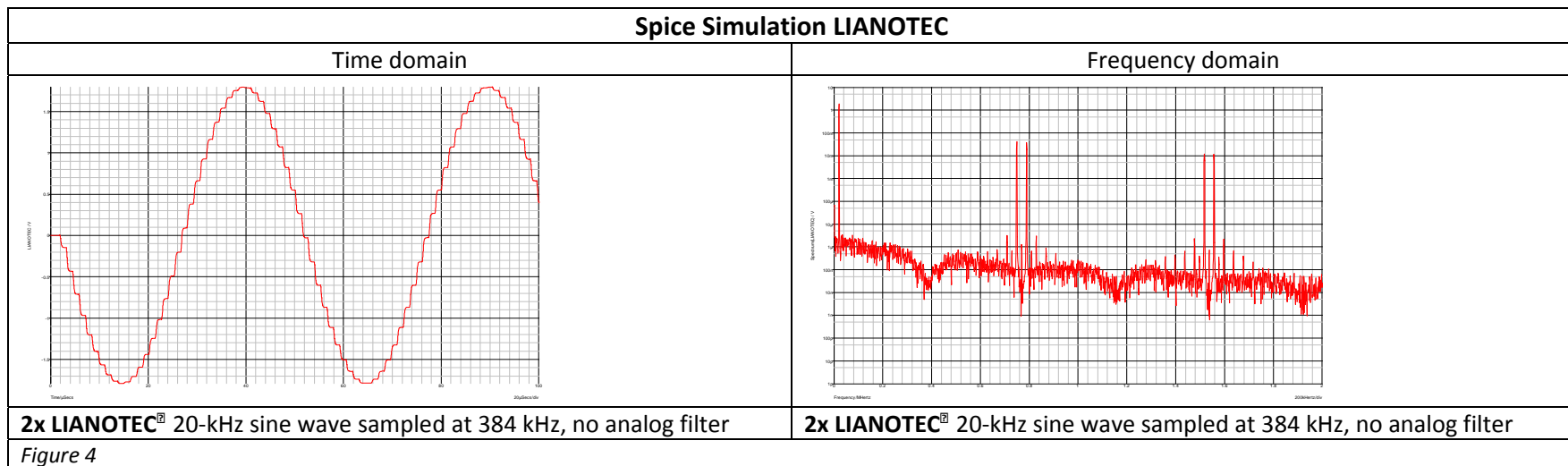

4x LIANOTEC

The result of a 4-way analog oversampling setup is depicted in Figure 5.

Here, the sidebands at 768 kHz are suppressed as well as at all the odd multiples of 768 kHz.

What remains are the sidebands at 1.536 MHz and their multiples.

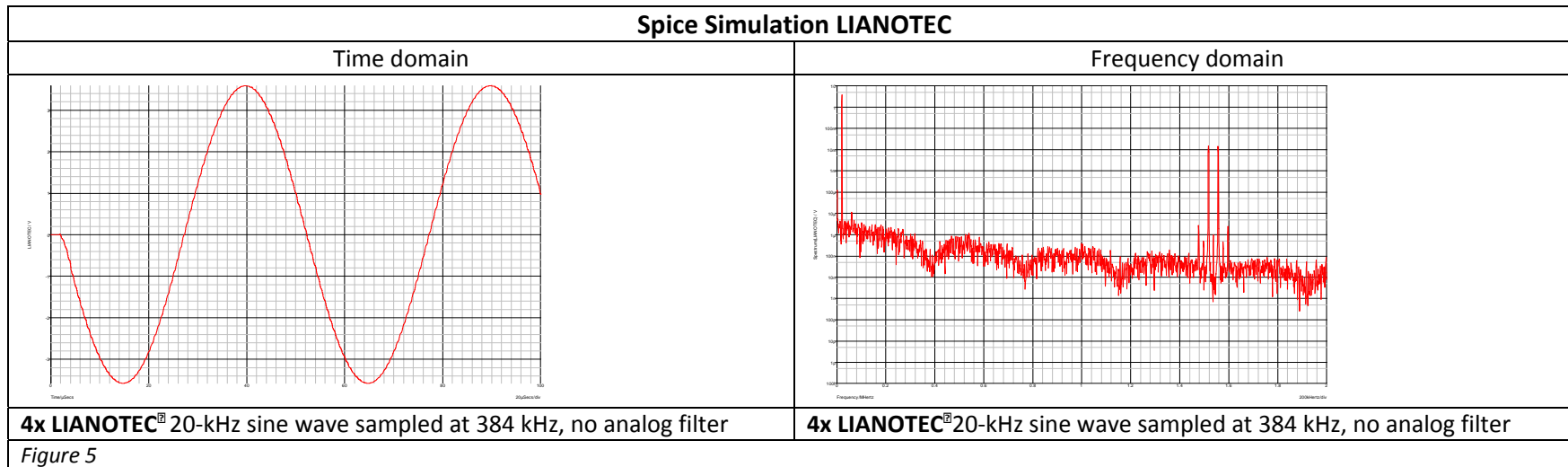
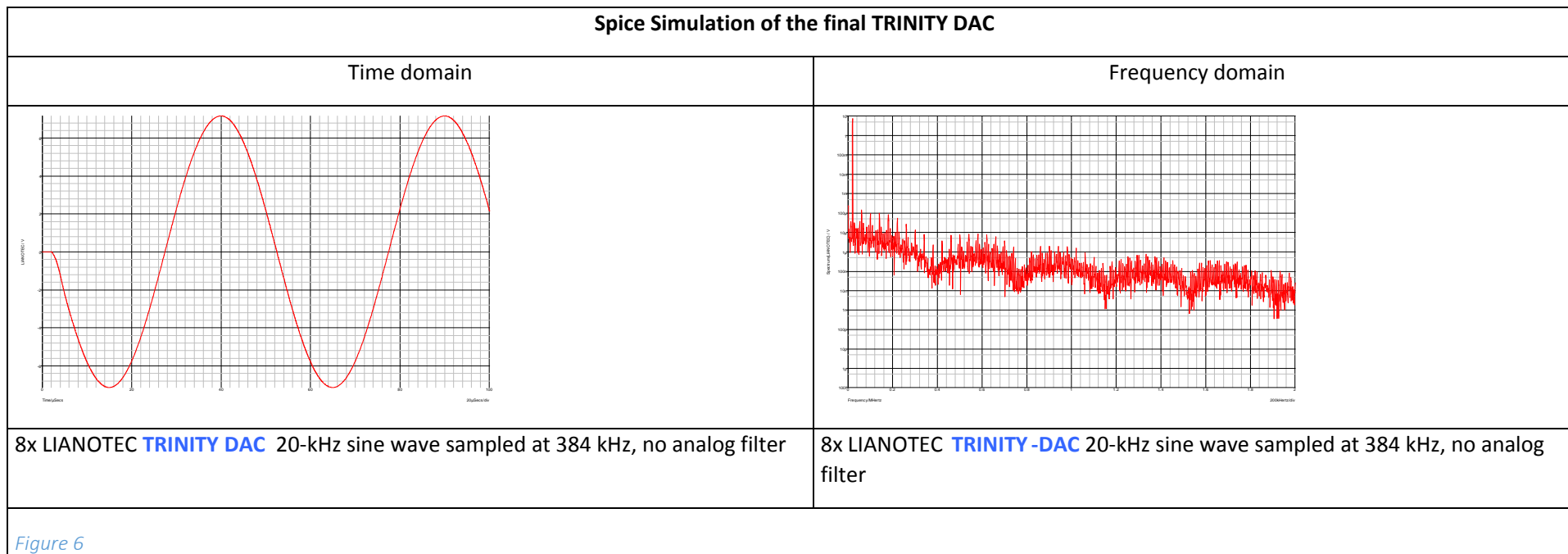

Figure 5

8x LIANOTEC

Figure 6, shows an **8-times oversampling setup as realized in the TRINITY DAC**, where the 1.536 MHz and their odd multiples are also erased. What remains are the sidebands at 3.072 MHz and their multiples. In other words, with an 8-way analog oversampling setup, the first sideband is located at 3.072 MHz and, therefore, is far outside of the bandwidth for conventional power amplifiers.



Compared with the usual circuitry comprising analog low-pass filters mentioned at the start, the LIANOTEC[®] topology produces significantly better sideband suppression. This means that, although there is no analog active low-pass filter in the signal path of the TRINITY[®] DAC, filtering is much enhanced by several orders of magnitude than conventional D/A converters.

IMPULSE RESPONSE

But this is far from being the only improvement that LIANOTEC[®] offers. It is well known that all digital oversampling techniques can be characterized by their impulse responses. As such, there are solutions that are impulse-optimized and those that are frequency response-optimized. The LIANOTEC[®] topology is both impulse-optimized and frequency response-optimized, since it has an **ideal** impulse response and, therefore, represents the epitome of interpolation techniques. *Figure 7* shows the reproduction of a 10-kHz square-wave signal sampled at 192kHz. The LIANOTEC[®] arrangement depicts a perfect square.

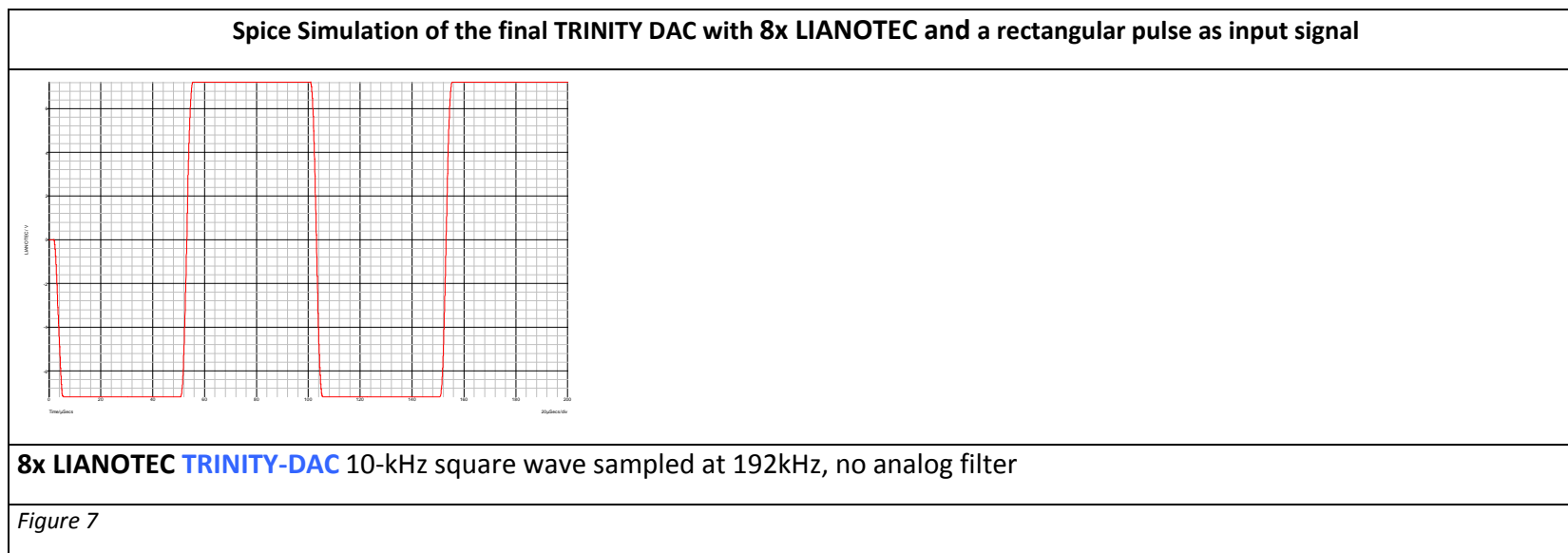



Summary

LIANOTEC

is a patented unique topology which improves all parameters of a multi-bit D/A converter.

The Asynchronous USB Interface

In Asynchronous Mode the DAC is the clock master, and the PC is acting as a slave that delivers data only when requested by the DAC. Using high speed USB 2.0 transmission, data are delivered much faster than the playback rate. The on board DSP manages a memory buffer and controls the USB transmission to make sure that the buffer never gets empty during playback. In an asynchrony USB interface the data are transferred with the USB clock rate from the PC to the memory of the USB interface. The high accuracy and low jitter clocks are used to read out this data with the exact sampling rate. The DAC gets now a data stream in exactly the same way as the “master tape”.

- Full galvanic isolation avoids any interference issues between the DAC and the PC. Critical components are powered by the low noise power supply of the DAC to ensure optimal performances.
- Because the use of full custom made high accurate and low jitter VCOCXOs eliminates the jitter caused by the PC hardware and software, this concept allows for superior playback performances when compared to other usual audio interfaces. The VCOCXO needs 180seconds to warm up.
- As mentioned in the block diagram (Figure 8) the TRINITY DAC has implemented two of the best VCOCXOs (**22.579200MHz** and **24.576000MHz**) on the market.
- The significant advantage is, that all recordings (**44.1kHz, 88.2kHz and 176.4kHz** & **48kHz, 96kHz and 192kHz**) are plaid back in its native sample rate and are not manipulate by a asynchrony sample rate converter (ASRC).

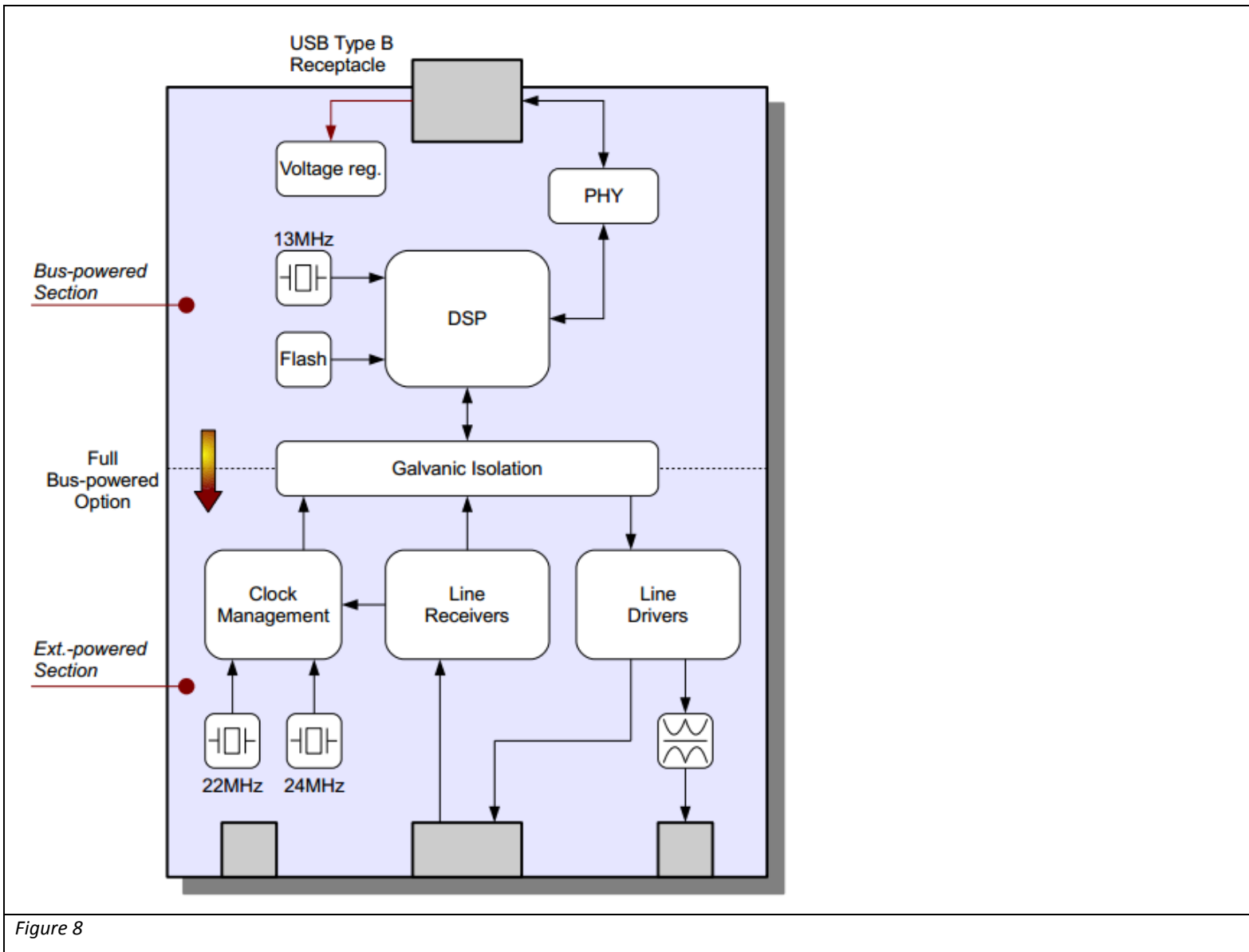

Figure 8

The Voltage Controlled Oven Controlled Xrystal Oscillator (VCOCXO)

The sampling process can be mathematically described as a convolution of a rectangular clock signal with the analog “music” signal. It can be mathematically shown, that the playback accuracy depends on the clock jitter and on the DAC architecture.

Even if the LIANOTEC architecture is very insensitive to jitter, the use of the best oscillators is a must for a TRINITY DAC. Figure 8 shows the outstanding performance of the two TRINITY VCOCXOs measured with a Modulation Domain Analyser synchronized with a Rubidium Frequency Normal.

The design target for these oscillators was to combine the accuracy of a voltage controlled oscillator with the stability of an oven controlled oscillator to get master clock with extreme low jitter of **28fs** (10Hz-100kHz) and an outstanding accuracy of **1ppb**.

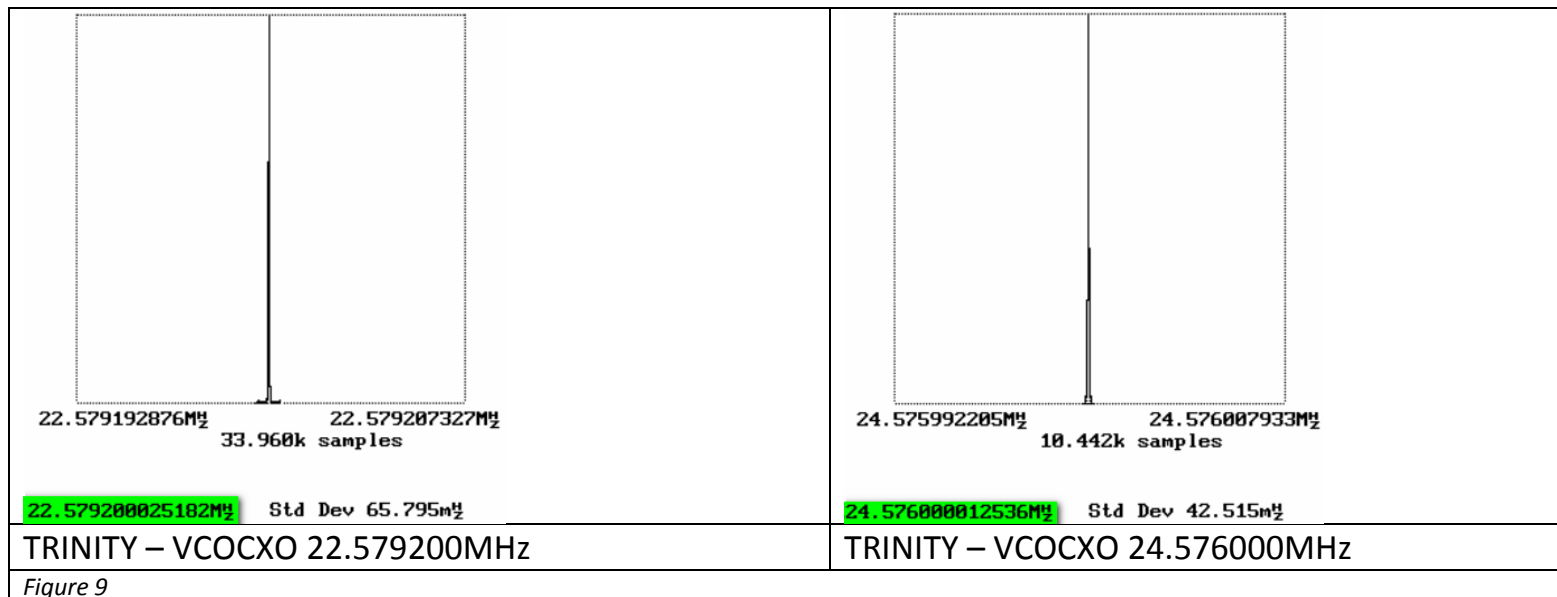



THE FINAL MEASUREMENTS

All TRINITY devices are shipped with a complete measurement protocol and not with some “typical” value published on the web page or in the data sheet.

What you see (in the measurement results) is what you get.

The measurements are done after a burn-in of 48hours.

SPDIF Input

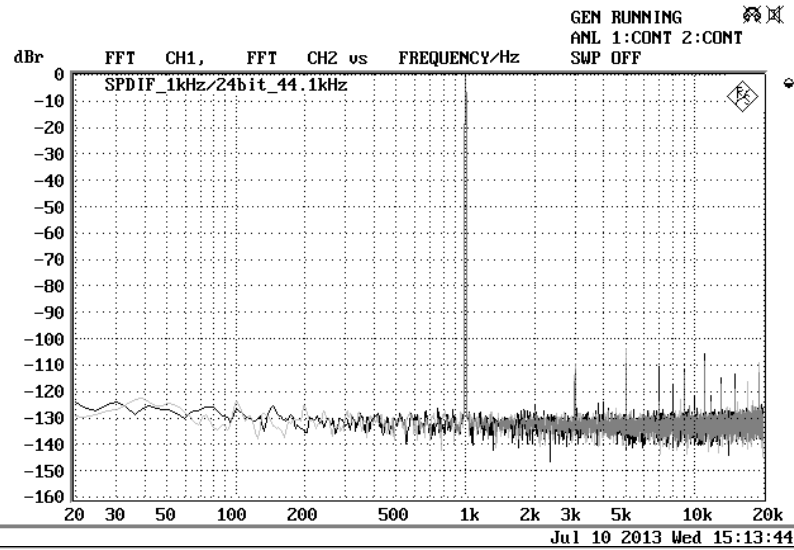

USB Input

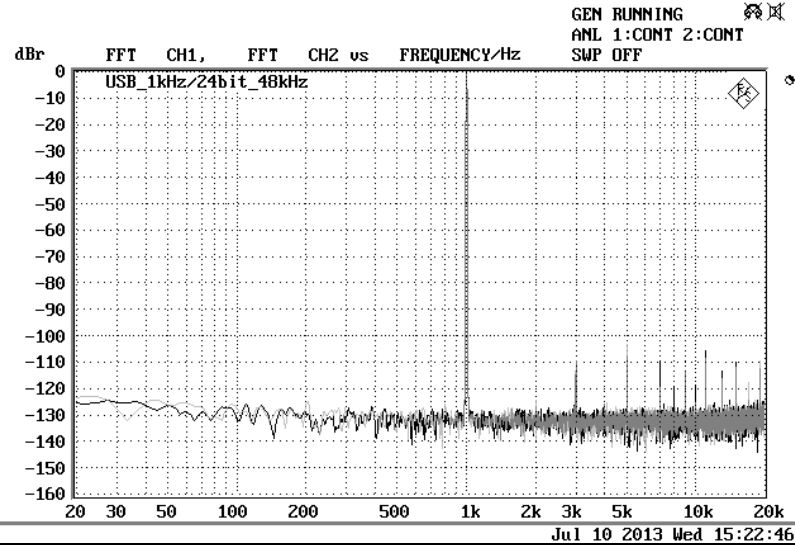
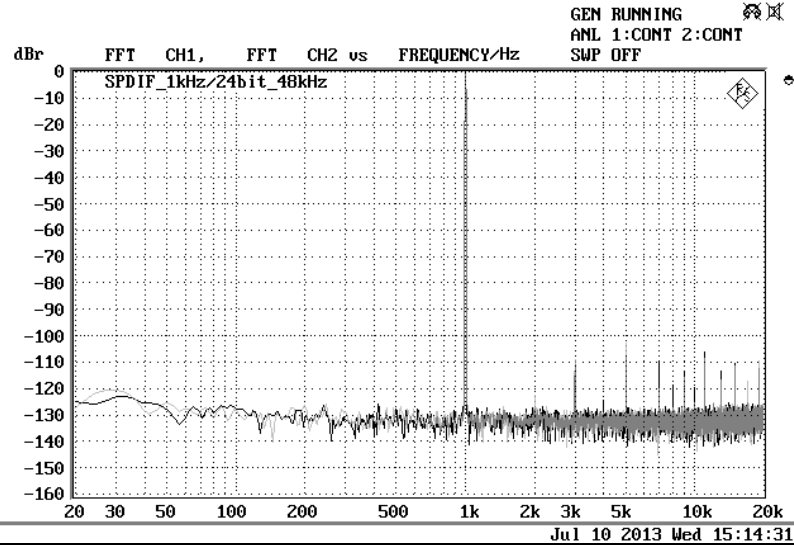
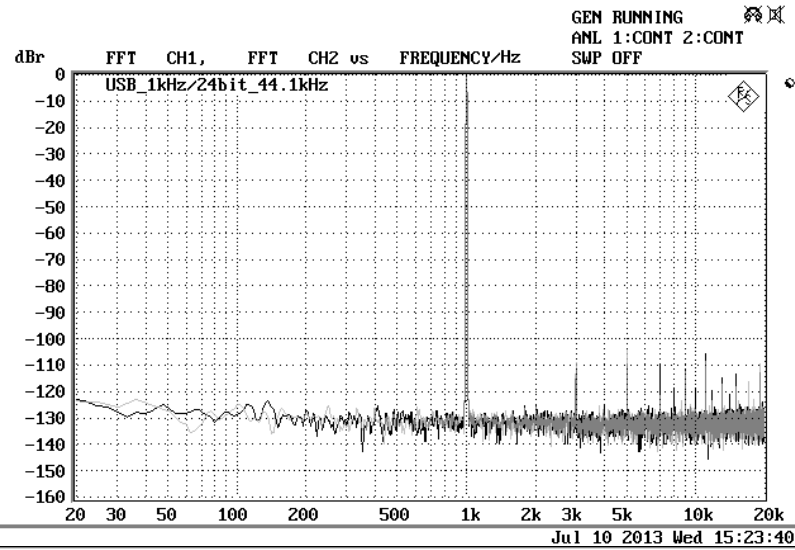

SPDIF Input

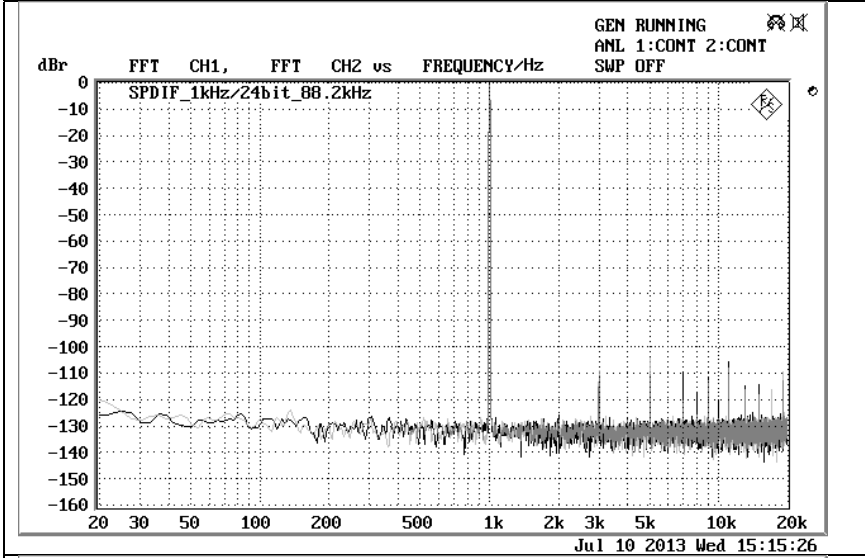

USB Input

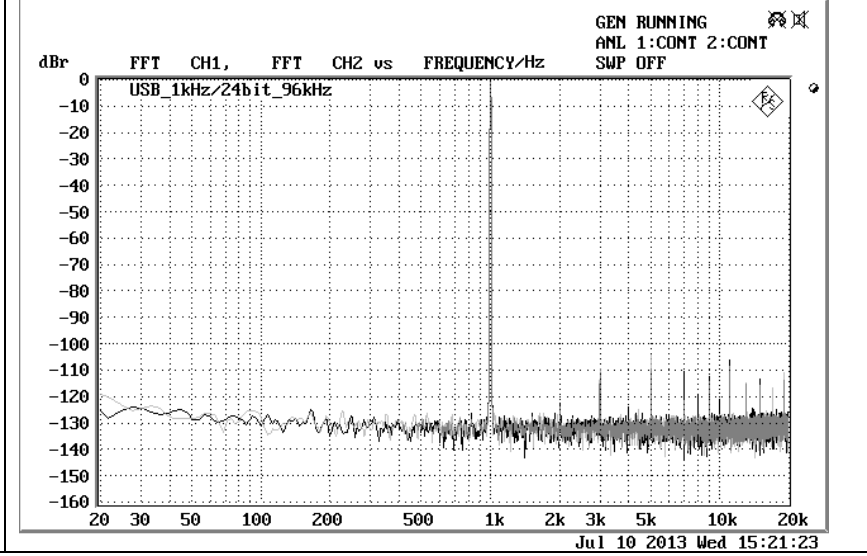
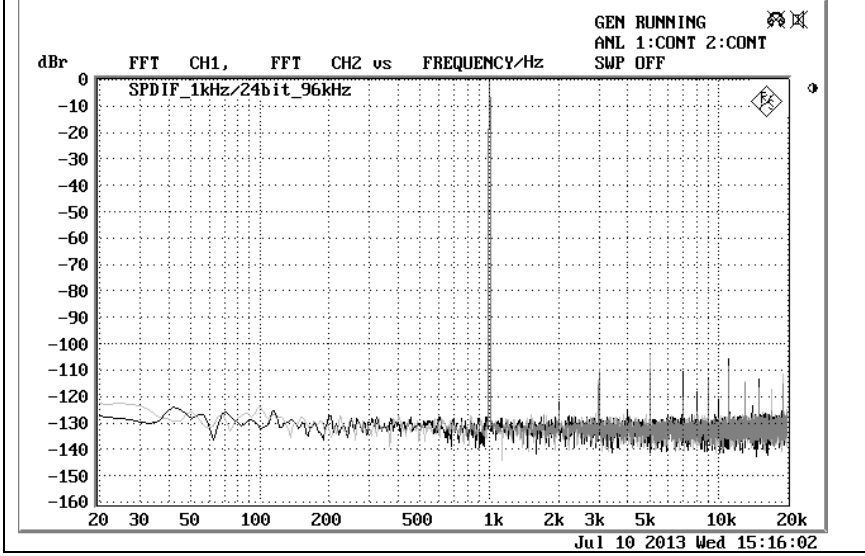
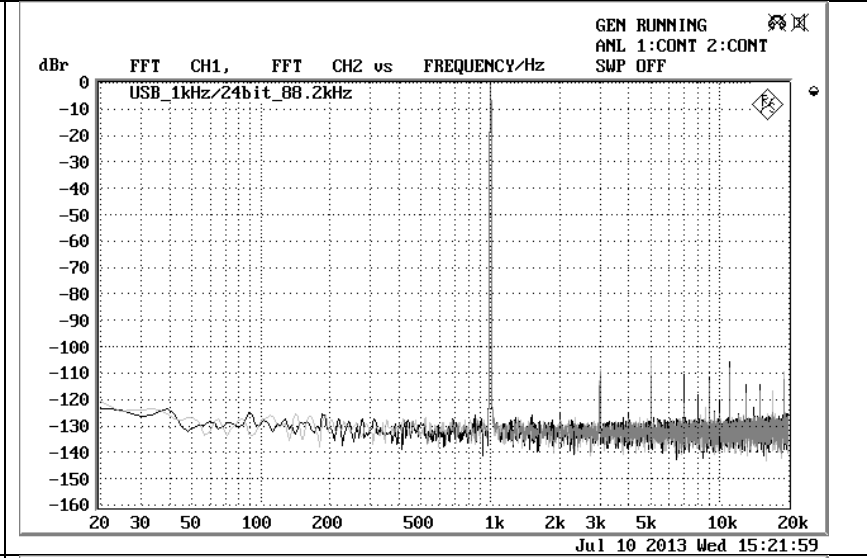

SPDIF Input

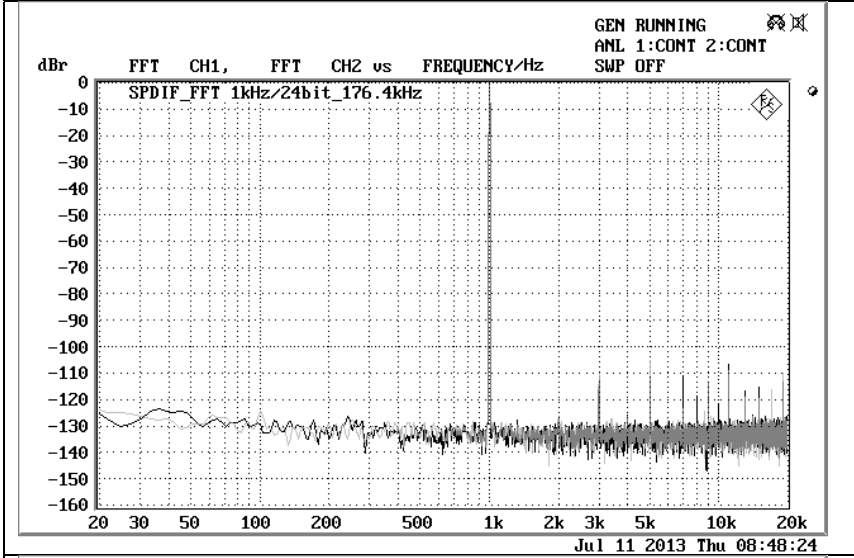

USB Input

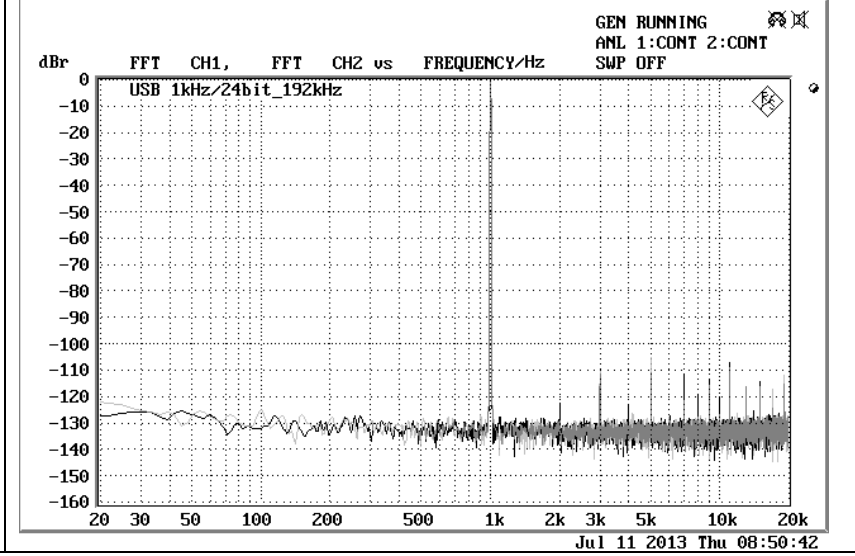
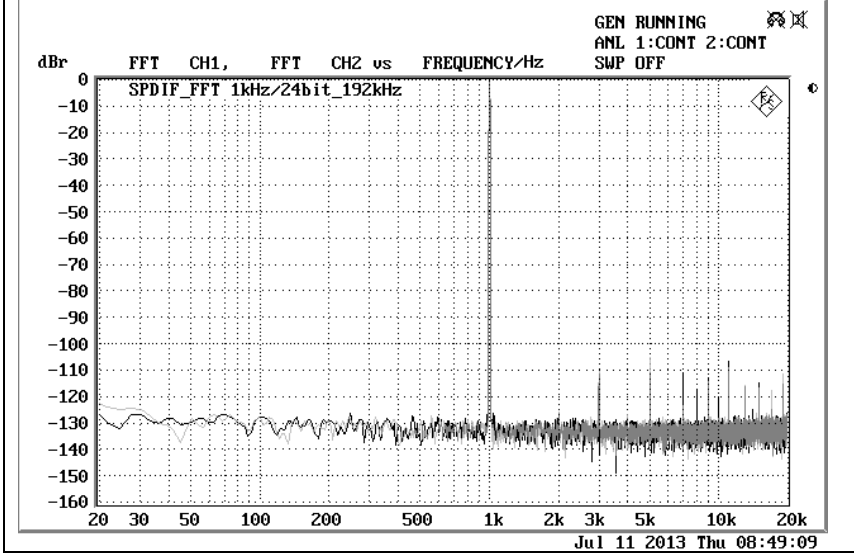
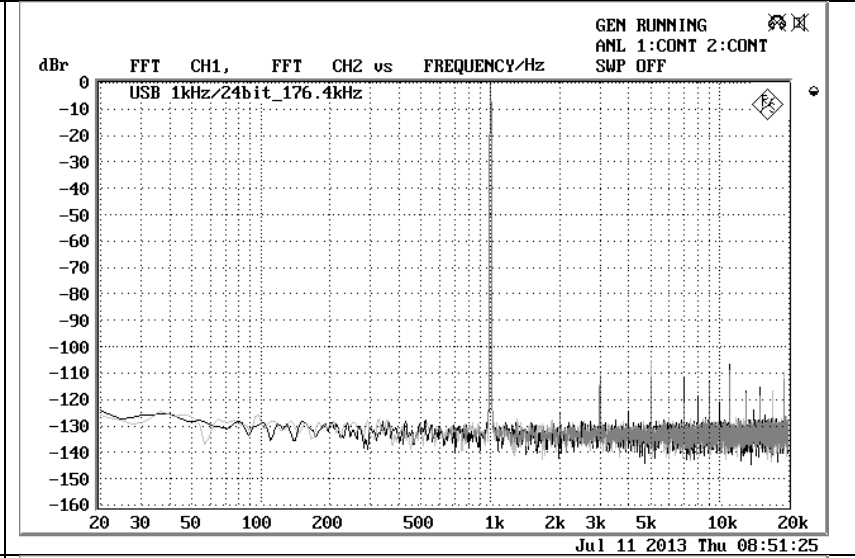

SPDIF Input

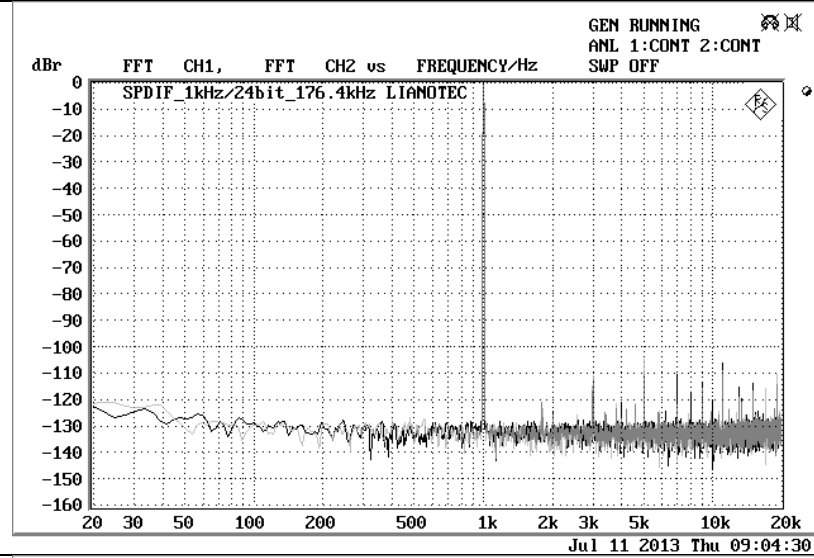

USB Input

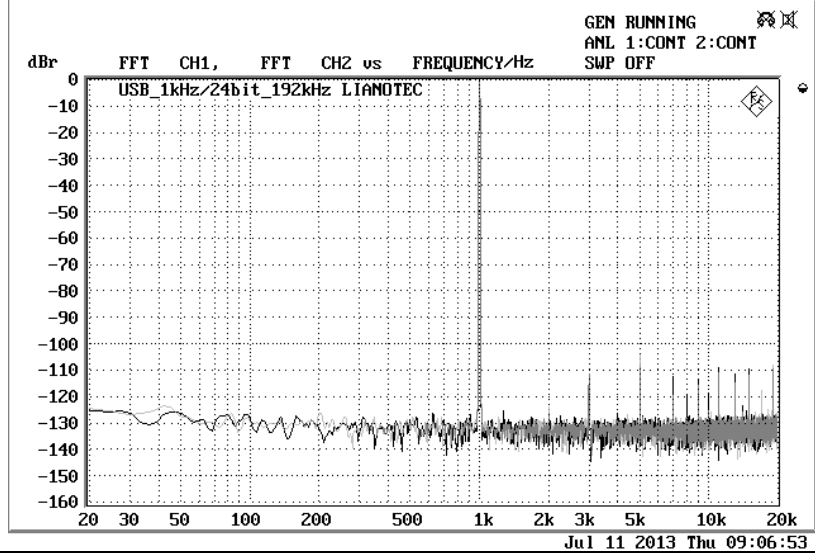
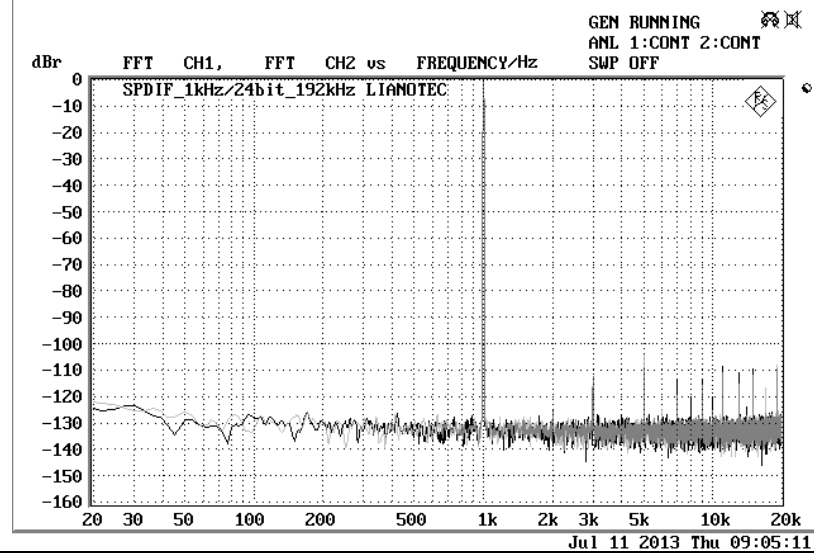
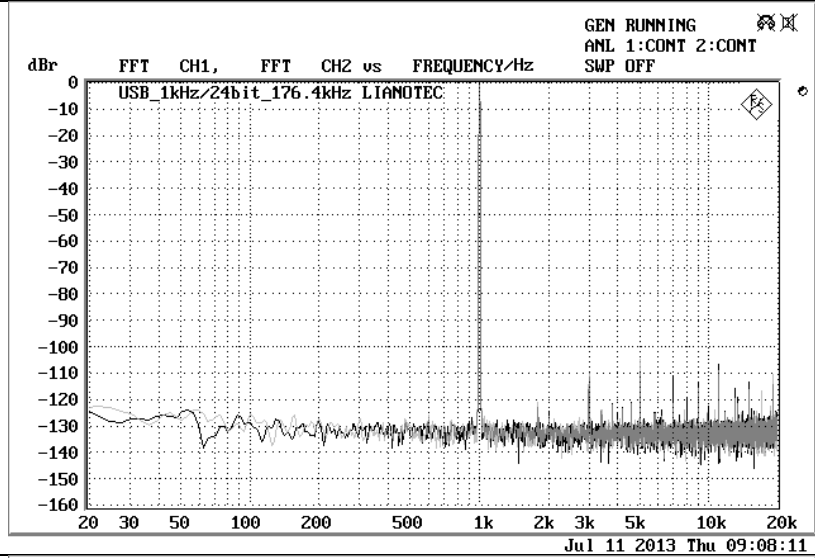

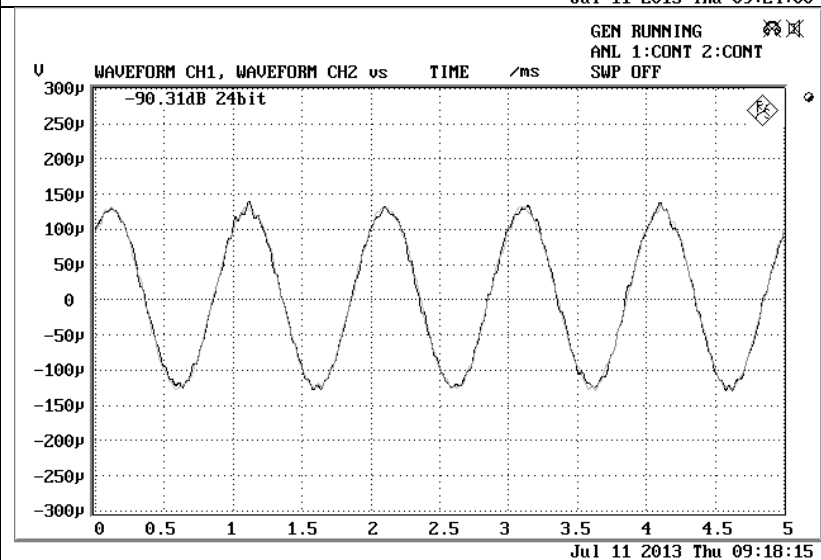
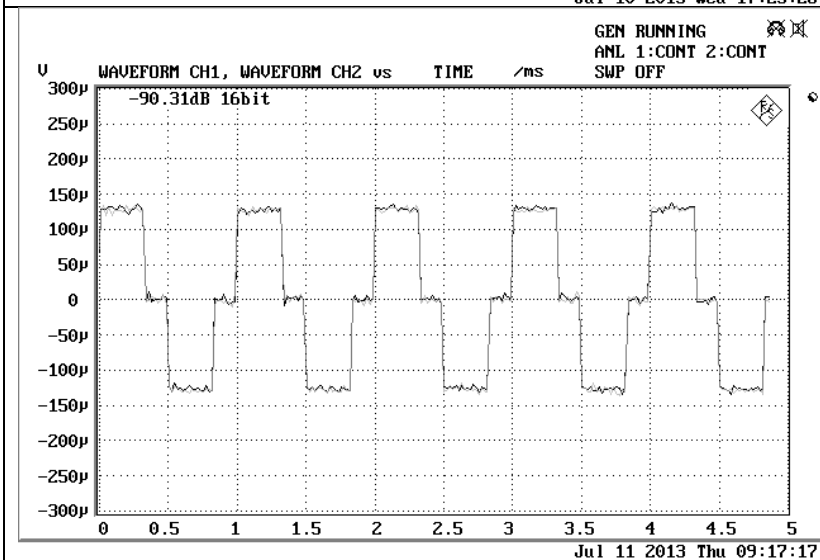
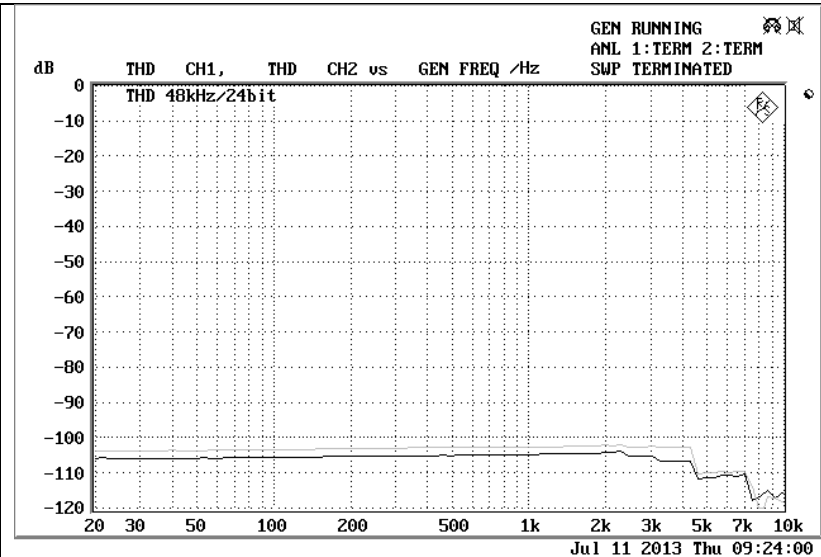
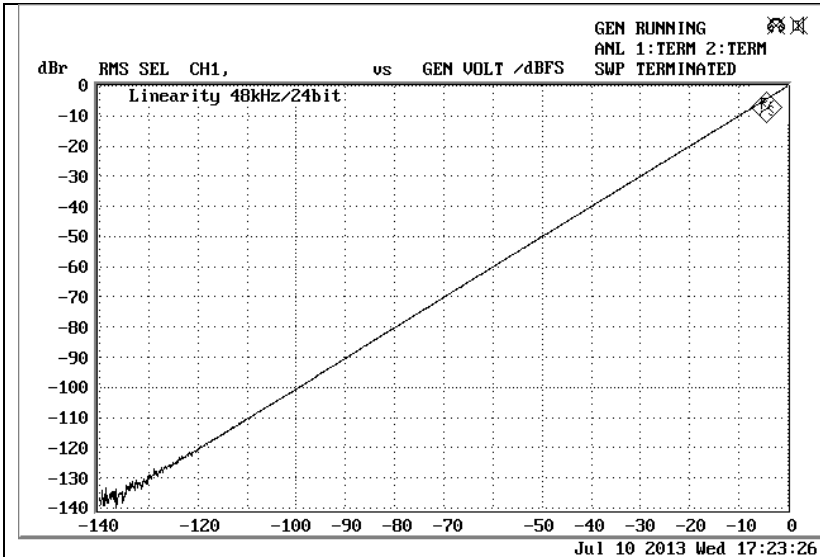

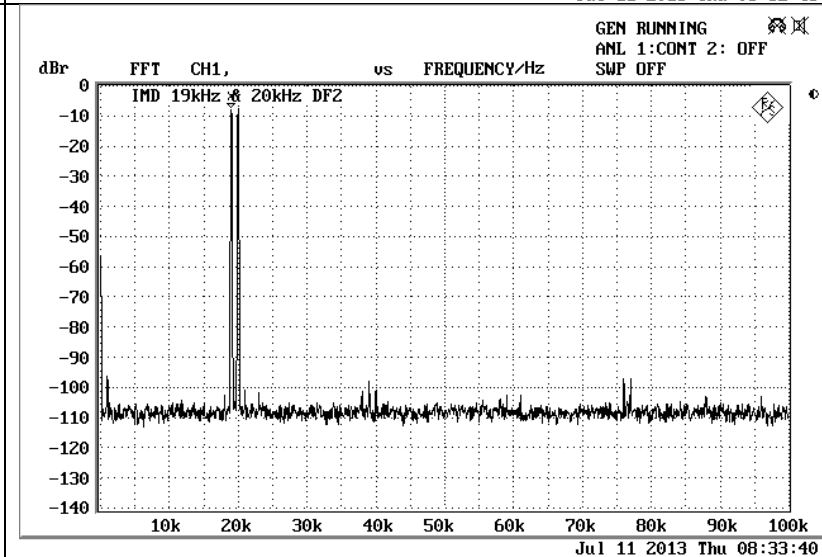
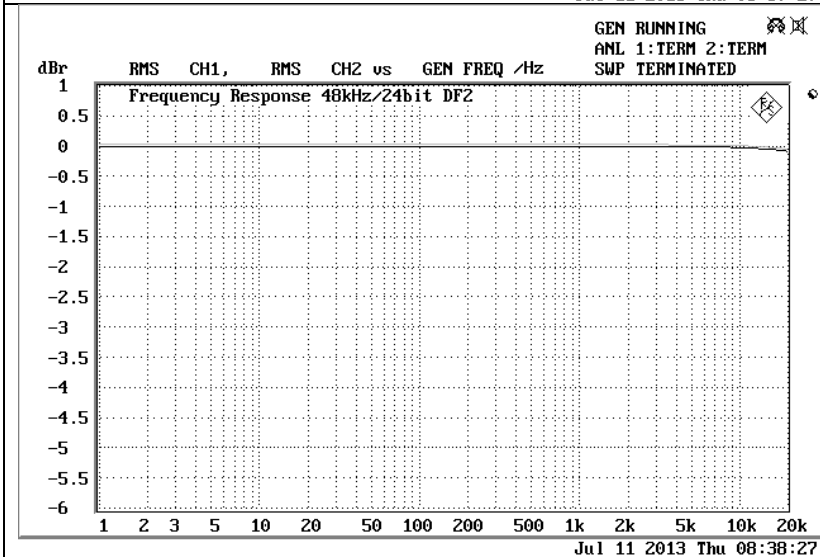
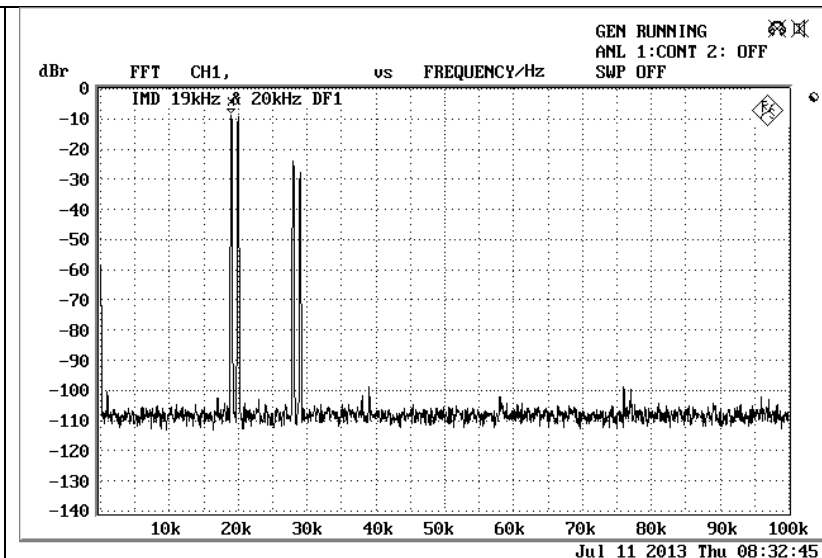
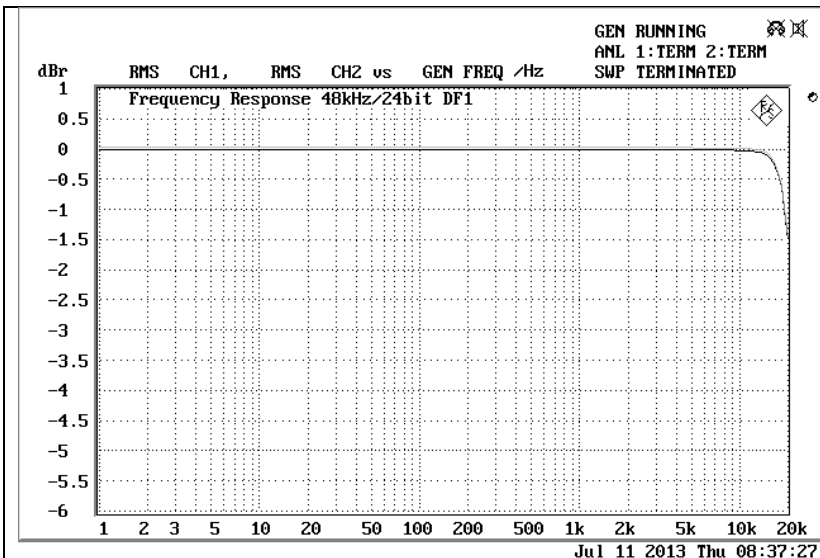

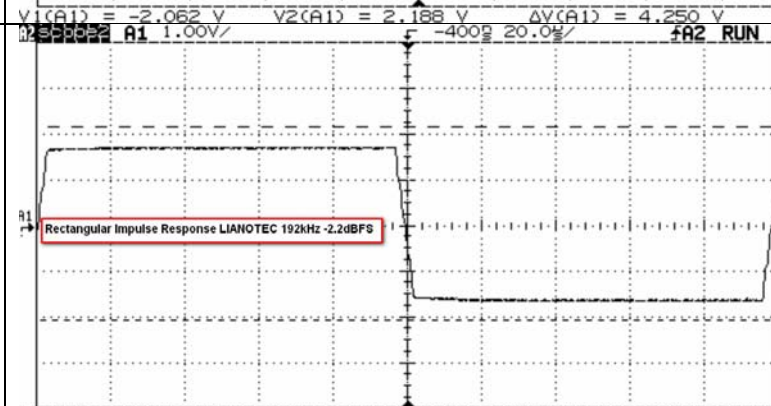
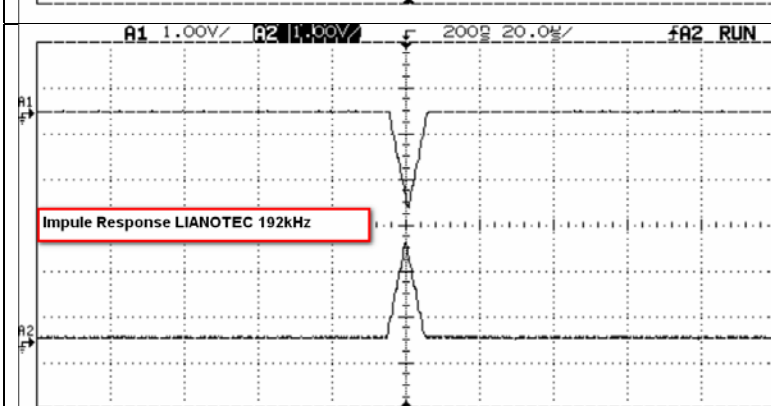
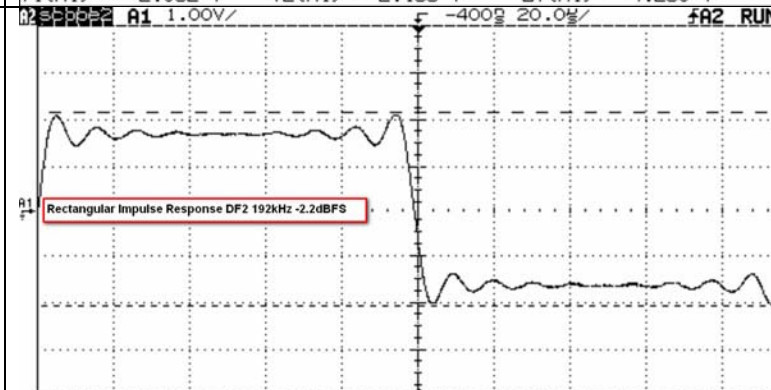
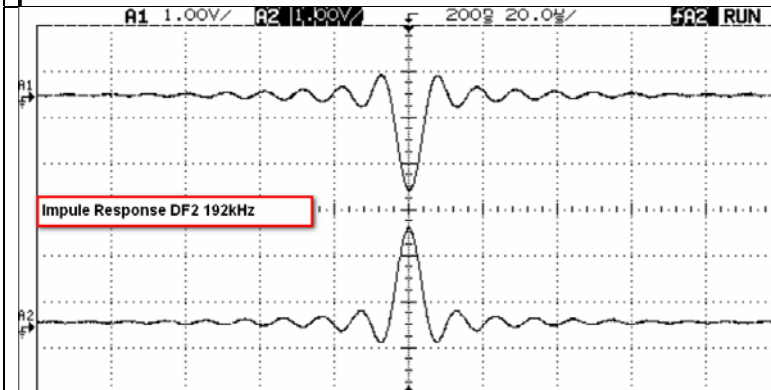
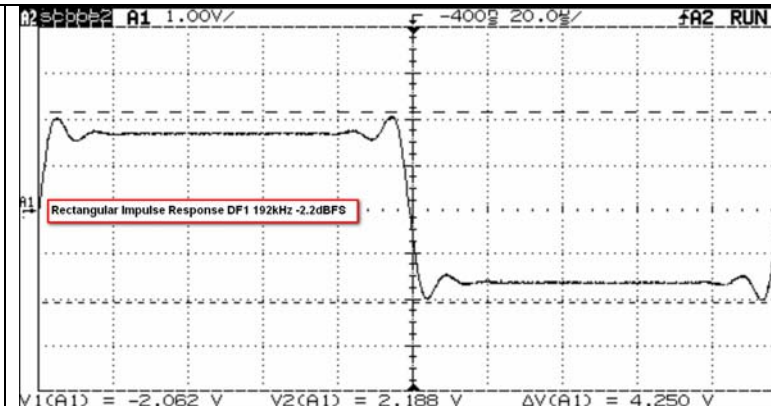
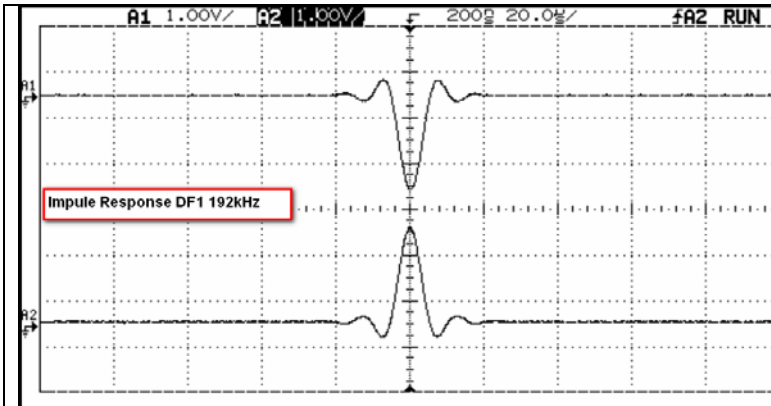

Important Note about Headroom for the Digital Filters

Each digital filter needs some headroom to work properly. The reason is that the digital algorithm can create numbers greater than one. This is visible as overshoots or ringing on the impulse response test.

The Impulse response test with a single 1bit, is nothing else than a read-out of the filter coefficients of the used digital filter.

Another test is to use a rectangular pulse. Figure 9 compares to 2 recordings of a rectangular pulse with different volume levels.

One is recorded with 0dBFS (no headroom) and the other is recorded with -2.2dBFS headroom.

It can be seen that recordings with recording levels higher than -2.2dBFS will create a digital clipping during playback.

This is valid for all Digital Analog Converters. The necessary headroom depends on the used digital filter.

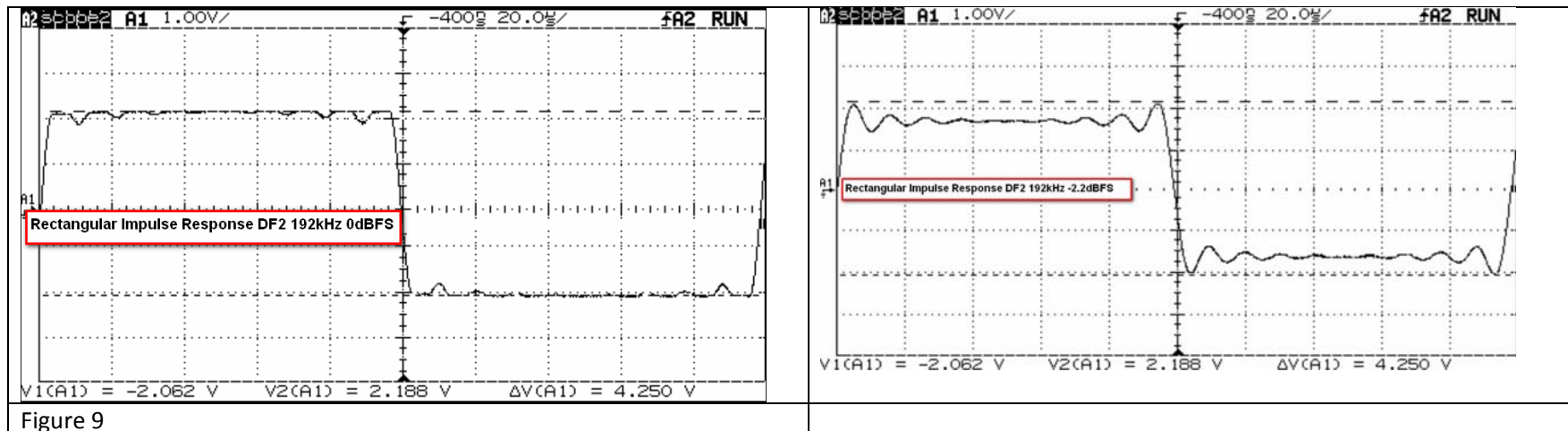



WARRANTY

The warranty period of the Trinity DAC is 2 years.

- Within the warranty period, any material and production defects will be rectified according to the following conditions:
- The warranty period begins with the purchase of the product and only applies to first buyers.
- A warranty claim is only valid if defects originating from material or manufacturing defects occur, but not as the result of natural wear and tear. In case of justified claims that occur during the warranty time, we will either repair the affected component free of charge or replace it at our discretion. In so doing, we are entitled to also supply a successor model in the interests of technical progress. Any further claims, in particular compensation damage of any nature, are excluded.
- The warranty period is not extended by any work performed during the warranty period, neither for replaced nor repaired components.
- Any improper handling or interventions by persons not authorized by TRINITY Electronic Design GmbH will render the warranty claim null and void. This also applies to damage arising from improper connection or use.
- The warranty excludes transportation damage that must be claimed immediately from the forwarding agency (railway, post, carrier). Any scratches on the enclosure or other visible defects must be reported to the dealer within 3 days.
- The provisions of the German product liability law and comparable foreign regulations remain unaffected, provided they are inalienable. We retain the right to make technical changes in the interests of technical progress



SUPPORT

If you have any questions relating to installation, operation or options, we will be pleased to answer them.

TRINITY Electronic Design GmbH

Johann Wieser Ring 11
8609 Aschheim, Germany

Tel. +49 (0) 89 – 20186577

E-mail. db@trinity-ed.de

Internet: <http://www.trinity-ed.de>